

| A  | B     | Ref.-No. Bestell-Nr. | Force / Kraft $F_1$ [N] |
|----|-------|----------------------|-------------------------|
| 20 | 106,5 | 192910               | 50                      |
|    |       | 192920               | 100                     |
|    |       | 192937               | 150                     |
|    |       | 192945               | 200                     |
|    |       | 192953               | 250                     |
|    |       | 192961               | 300                     |
|    |       | 192988               | 350                     |
|    |       | 192996               | 400                     |
| 40 | 145,5 | 185175               | 50                      |
|    |       | 191752               | 100                     |
|    |       | 192805               | 150                     |
|    |       | 192813               | 200                     |
|    |       | 192821               | 250                     |
|    |       | 082309               | 300                     |
|    |       | 082317               | 350                     |
|    |       | 094307               | 400                     |
| 60 | 185,5 | 192848               | 50                      |
|    |       | 192856               | 100                     |
|    |       | 192864               | 150                     |
|    |       | 192872               | 200                     |
|    |       | 192880               | 250                     |
|    |       | 082384               | 300                     |
|    |       | 082392               | 350                     |
|    |       | 094315               | 400                     |
| 80 | 226,5 | 082406               | 50                      |
|    |       | 082414               | 100                     |
|    |       | 082422               | 150                     |
|    |       | 082430               | 200                     |
|    |       | 082449               | 250                     |
|    |       | 082457               | 300                     |
|    |       | 082465               | 350                     |
|    |       | 094323               | 400                     |

| A   | B     | Ref.-No. Bestell-Nr. | Force / Kraft $F_1$ [N] |
|-----|-------|----------------------|-------------------------|
| 100 | 265,5 | 082473               | 50                      |
|     |       | 082481               | 100                     |
|     |       | 082503               | 150                     |
|     |       | 082511               | 200                     |
|     |       | 082538               | 250                     |
|     |       | 082546               | 300                     |
|     |       | 082554               | 350                     |
|     |       | 094331               | 400                     |
| 120 | 305,5 | 082562               | 50                      |
|     |       | 082570               | 100                     |
|     |       | 082589               | 150                     |
|     |       | 082597               | 200                     |
|     |       | 082600               | 250                     |
|     |       | 082627               | 300                     |
|     |       | 082635               | 350                     |
|     |       | 094338               | 400                     |
| 150 | 365,5 | 082643               | 50                      |
|     |       | 082651               | 100                     |
|     |       | 082678               | 150                     |
|     |       | 082686               | 200                     |
|     |       | 082694               | 250                     |
|     |       | 082708               | 300                     |
|     |       | 082716               | 350                     |
|     |       | 675605               | 400                     |

| D1 [mm] | D2 [mm] | Force of extension Ausschubkraft $F_1$ [N] | Stroke max. Hub [mm] | x (°) | $F_R$ max. [N] |
|---------|---------|--|----------------------|-------|----------------|
| 6       | 15      | 50 - 400                                   | 150                  | 1,30  | 50             |
| 8       | 19      | 100 - 800                                  | 250                  | 1,35  | 60             |
| 10      | 22      | 150 - 1150                                 | 400                  | 1,40  | 80             |
| 14      | 28      | 500 - 2100                                 | 500                  | 1,50  | 80             |
| 20      | 42      | 2400 - 5200                                | 500                  | 1,45  | 150            |

Installation instruction  
Einbauvorschrift  
STAB-Spec. 1000 5593

Statically measured forces  
Statische Messung der Kräfte  
STAB-Spec. 1000 9033

Disposal instruction  
Entsorgungsvorschrift  
STAB-Spec. 1000 9375  
[www.Stabilus.com/service-spare-parts/recycling/](http://www.Stabilus.com/service-spare-parts/recycling/)  
[www.Stabilus.de/service-ersatzteile/recycling/](http://www.Stabilus.de/service-ersatzteile/recycling/)

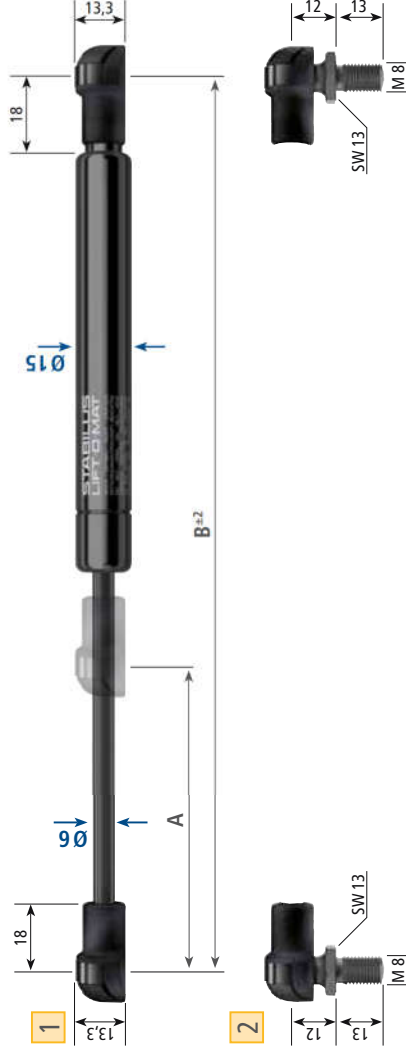

Suitable for ball studs according to DIN 71803 Ø 10  
Passend für Kugelzapfen nach DIN 71803 Ø 10

| A          |                                 | B                       |                      | 1          |                                 | 2                       |                      |
|------------|---------------------------------|-------------------------|----------------------|------------|---------------------------------|-------------------------|----------------------|
| Stroke Hub | Extended length Ausgesch. Länge | Force / Kraft $F_1$ [N] | Ref.-No. Bestell-Nr. | Stroke Hub | Extended length Ausgesch. Länge | Force / Kraft $F_1$ [N] | Ref.-No. Bestell-Nr. |
| 20         | 115,5                           | 50                      | 4727PB               | 4829DF     | 100                             | 4728PX                  | 4832DH               |
|            |                                 | 100                     | 4729PS               | 4834DY     | 150                             | 4731PZ                  | 1324DI               |
|            |                                 | 200                     | 4732PU               | 4836DO     | 250                             | 4733PP                  | 4838DE               |
|            |                                 | 300                     | 4734PK               | 4842DB     | 350                             | 4735PF                  | 4844DS               |
|            |                                 | 400                     | 4735PF               | 4844DS     | 50                              | 2606NW                  | 4846DI               |
| 40         | 155,5                           | 100                     | 2607NR               | 4848DZ     | 150                             | 2608NM                  | 4851DA               |
|            |                                 | 200                     | 2609NH               | 1338DJ     | 250                             | 2611NO                  | 4853DR               |
|            |                                 | 300                     | 2612NJ               | 4855DH     | 350                             | 2613NE                  | 4857DY               |
|            |                                 | 400                     | 2615NV               | 4859DO     | 50                              | 6444IK                  | 4862DQ               |
| 60         | 195,5                           | 100                     | 6488IU               | 4534DS     | 150                             | 6489IW                  | 4904DI               |
|            |                                 | 200                     | 6491IW               | 1345DS     | 250                             | 6492IR                  | 4906DZ               |
|            |                                 | 300                     | 6493IM               | 4908DP     | 350                             | 6494IH                  | 4911DR               |
|            |                                 | 400                     | 6495IC               | 4913DH     | 50                              | 6449IM                  | 4915DY               |
| 80         | 235,5                           | 100                     | 6501IP               | 4917DO     | 150                             | 6502IK                  | 4919DE               |
|            |                                 | 200                     | 6503IF               | 1395DP     | 250                             | 6504IA                  | 4922DG               |
|            |                                 | 300                     | 6505IW               | 4924DX     | 350                             | 6506IR                  | 4926DN               |
|            |                                 | 400                     | 6507IM               | 4928DD     |                                 |                         |                      |



| A          |                                 | B                       |                      | 1          |                                 | 2                       |                      |
|------------|---------------------------------|-------------------------|----------------------|------------|---------------------------------|-------------------------|----------------------|
| Stroke Hub | Extended length Ausgesch. Länge | Force / Kraft $F_1$ [N] | Ref.-No. Bestell-Nr. | Stroke Hub | Extended length Ausgesch. Länge | Force / Kraft $F_1$ [N] | Ref.-No. Bestell-Nr. |
| 60         | 205                             | 500                     | 084018               | 80         | 245                             | 500                     | 084093               |
|            |                                 | 600                     | 084026               |            |                                 | 700                     | 084115               |
|            |                                 | 700                     | 084034               |            |                                 | 800                     | 084115               |
|            |                                 | 800                     | 094684               | 100        | 285                             | 500                     | 084174               |
|            |                                 | 500                     | 084093               |            |                                 | 600                     | 084182               |
|            |                                 | 600                     | 084107               |            |                                 | 700                     | 084190               |
|            |                                 | 700                     | 084115               |            |                                 | 800                     | 094706               |
|            |                                 | 800                     | 094692               | 120        | 325                             | 500                     | 084247               |
|            |                                 | 500                     | 084174               |            |                                 | 600                     | 094714               |
|            |                                 | 600                     | 084182               |            |                                 | 700                     | 084263               |
|            |                                 | 700                     | 084190               |            |                                 | 800                     | 094722               |
|            |                                 | 800                     | 094706               | 140        | 365                             | 500                     | 084352               |
|            |                                 | 500                     | 084093               |            |                                 | 600                     | 084360               |
|            |                                 | 600                     | 084107               |            |                                 | 700                     | 084379               |
|            |                                 | 700                     | 084115               |            |                                 | 800                     | 084387               |
|            |                                 | 800                     | 084115               | 160        | 405                             | 100                     | 084395               |
|            |                                 | 500                     | 084174               |            |                                 | 150                     | 094765               |
|            |                                 | 600                     | 084182               |            |                                 | 200                     | 084409               |
|            |                                 | 700                     | 084190               |            |                                 | 250                     | 094773               |
|            |                                 | 800                     | 094706               |            |                                 | 300                     | 084417               |
|            |                                 | 500                     | 084093               |            |                                 | 350                     | 094781               |
|            |                                 | 600                     | 084107               |            |                                 | 400                     | 084425               |
|            |                                 | 700                     | 084115               |            |                                 | 500                     | 084476               |
|            |                                 | 800                     | 094692               |            |                                 | 600                     | 084484               |
|            |                                 | 500                     | 084174               |            |                                 | 700                     | 084492               |
|            |                                 | 600                     | 084182               |            |                                 | 800                     | 094757               |
|            |                                 | 700                     | 084190               | 180        | 445                             | 100                     | 084506               |
|            |                                 | 800                     | 094706               |            |                                 | 150                     | 094803               |
|            |                                 | 500                     | 084093               |            |                                 | 200                     | 084514               |
|            |                                 | 600                     | 084107               |            |                                 | 250                     | 094811               |
|            |                                 | 700                     | 084115               |            |                                 | 300                     | 084522               |
|            |                                 | 800                     | 084115               |            |                                 | 350                     | 094838               |
|            |                                 | 500                     | 084174               |            |                                 | 400                     | 086363               |
|            |                                 | 600                     | 084182               |            |                                 | 500                     | 084549               |
|            |                                 | 700                     | 084190               |            |                                 | 600                     | 084557               |
|            |                                 | 800                     | 094706               |            |                                 | 700                     | 084565               |
|            |                                 | 500                     | 084093               |            |                                 | 800                     | 094846               |

| A          |                                 | B                       |                      | 1          |                                 | 2                       |                      |
|------------|---------------------------------|-------------------------|----------------------|------------|---------------------------------|-------------------------|----------------------|
| Stroke Hub | Extended length Ausgesch. Länge | Force / Kraft $F_1$ [N] | Ref.-No. Bestell-Nr. | Stroke Hub | Extended length Ausgesch. Länge | Force / Kraft $F_1$ [N] | Ref.-No. Bestell-Nr. |
| 200        | 485                             | 100                     | 084573               | 220        | 525                             | 100                     | 084662               |
|            |                                 | 150                     | 094854               |            |                                 | 150                     | 094897               |
|            |                                 | 200                     | 084581               |            |                                 | 200                     | 084670               |
|            |                                 | 250                     | 094862               |            |                                 | 250                     | 094900               |
|            |                                 | 300                     | 084603               |            |                                 | 300                     | 084689               |
|            |                                 | 350                     | 094870               |            |                                 | 350                     | 094919               |
|            |                                 | 400                     | 084611               |            |                                 | 400                     | 084697               |
|            |                                 | 500                     | 084638               |            |                                 | 500                     | 084700               |
|            |                                 | 600                     | 084646               |            |                                 | 600                     | 084719               |
|            |                                 | 700                     | 084654               |            |                                 | 700                     | 084727               |
|            |                                 | 800                     | 094889               |            |                                 | 800                     | 094927               |
| 220        | 525                             | 100                     | 084662               | 250        | 585                             | 100                     | 084735               |
|            |                                 | 150                     | 094897               |            |                                 | 150                     | 094935               |
|            |                                 | 200                     | 084670               |            |                                 | 200                     | 084743               |
|            |                                 | 250                     | 094900               |            |                                 | 250                     | 094943               |
|            |                                 | 300                     | 084689               |            |                                 | 300                     | 084751               |
|            |                                 | 350                     | 094919               |            |                                 | 350                     | 094951               |
|            |                                 | 400                     | 084697               |            |                                 | 400                     | 084778               |
|            |                                 | 500                     | 084700               |            |                                 | 500                     | 084786               |
|            |                                 | 600                     | 084719               |            |                                 | 600                     | 084794               |
|            |                                 | 700                     | 084727               |            |                                 | 700                     | 084808               |
|            |                                 | 800                     | 094927               |            |                                 | 800                     | 094978               |

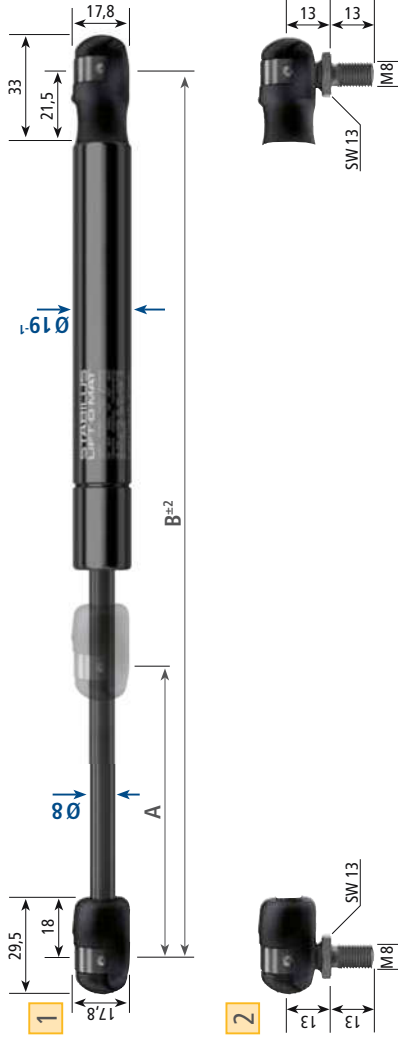

Suitable for ball studs according to DIN 71803 010  
Passend für Kugelzapfen nach DIN 71803 010

| A          | B                               | Force / Kraft F, [N] | 1                    | 2                    |
|------------|---------------------------------|----------------------|----------------------|----------------------|
| Stroke Hub | Extended length Ausgesch. Länge |                      | Ref.-No. Bestell-Nr. | Ref.-No. Bestell-Nr. |
| 60         | 205                             | 500                  | 2616NQ 094471        | 094471               |
|            |                                 | 600                  | 2617NL 083240        | 083240               |
|            |                                 | 700                  | 2618NG 083259        | 083259               |
|            |                                 | 800                  | 2619NB 094412        | 094412               |
| 80         | 245                             | 100                  | 752614 447609        | 447609               |
|            |                                 | 150                  | 752622 466441        | 466441               |
|            |                                 | 200                  | 1417EP 381926        | 381926               |
|            |                                 | 250                  | 752630 287806        | 287806               |
|            |                                 | 300                  | 1418EK 368237        | 368237               |
|            |                                 | 350                  | 1419EF 550817        | 550817               |
|            |                                 | 400                  | 752649 278076        | 278076               |
|            |                                 | 500                  | 752657 083305        | 083305               |
|            |                                 | 600                  | 752665 083313        | 083313               |
|            |                                 | 700                  | 2622ND 083321        | 083321               |
|            |                                 | 800                  | 2623NZ 094420        | 094420               |
| 100        | 285                             | 100                  | 752673 321400        | 321400               |
|            |                                 | 150                  | 752681 09275H        | 09275H               |
|            |                                 | 200                  | 1421EM 315826        | 315826               |
|            |                                 | 250                  | 752703 150344        | 150344               |
|            |                                 | 300                  | 1422EH 632600        | 632600               |
|            |                                 | 350                  | 1423EC 462047        | 462047               |
|            |                                 | 400                  | 752711 709492        | 709492               |
|            |                                 | 500                  | 752738 083380        | 083380               |
|            |                                 | 600                  | 752746 083399        | 083399               |
|            |                                 | 700                  | 2624NU 083402        | 083402               |
|            |                                 | 800                  | 2625NP 094439        | 094439               |

| A          | B                               | Force / Kraft F, [N] | 1                    | 2                    |
|------------|---------------------------------|----------------------|----------------------|----------------------|
| Stroke Hub | Extended length Ausgesch. Länge |                      | Ref.-No. Bestell-Nr. | Ref.-No. Bestell-Nr. |
| 120        | 325                             | 100                  | 752754 253308        | 253308               |
|            |                                 | 150                  | 752762 265802        | 265802               |
|            |                                 | 200                  | 1424EY 3008AM        | 3008AM               |
|            |                                 | 250                  | 752770 244880        | 244880               |
|            |                                 | 300                  | 1425ET 377007        | 377007               |
|            |                                 | 350                  | 1426EO 510599        | 510599               |
|            |                                 | 400                  | 752789 684872        | 684872               |
|            |                                 | 500                  | 752797 094498        | 094498               |
|            |                                 | 600                  | 752800 083461        | 083461               |
|            |                                 | 700                  | 2626NK 083488        | 083488               |
|            |                                 | 800                  | 2627NF 094447        | 094447               |
| 140        | 365                             | 100                  | 711506 177032        | 177032               |
|            |                                 | 150                  | 711745 287814        | 287814               |
|            |                                 | 200                  | 031970 630896        | 630896               |
|            |                                 | 250                  | 033973 253723        | 253723               |
|            |                                 | 300                  | 2819WF 3579UR        | 3579UR               |
|            |                                 | 350                  | 711984 152495        | 152495               |
|            |                                 | 400                  | 2628NA 083534        | 083534               |
|            |                                 | 500                  | 2629NW 083542        | 083542               |
|            |                                 | 600                  | 2631NC 083550        | 083550               |
|            |                                 | 700                  | 2632NY 083569        | 083569               |
|            |                                 | 800                  | 2633NT 094455        | 094455               |

| A          | B                               | Force / Kraft F, [N] | 1                    | 2                    |
|------------|---------------------------------|----------------------|----------------------|----------------------|
| Stroke Hub | Extended length Ausgesch. Länge |                      | Ref.-No. Bestell-Nr. | Ref.-No. Bestell-Nr. |
| 160        | 405                             | 100                  | 752819 083577        | 083577               |
|            |                                 | 150                  | 752827 095621        | 095621               |
|            |                                 | 200                  | 1427EJ 083585        | 083585               |
|            |                                 | 250                  | 752835 095648        | 095648               |
|            |                                 | 300                  | 1428EE 083593        | 083593               |
|            |                                 | 350                  | 1431EG 095656        | 095656               |
|            |                                 | 400                  | 752843 083607        | 083607               |
|            |                                 | 500                  | 752851 083615        | 083615               |
|            |                                 | 600                  | 752878 083623        | 083623               |
|            |                                 | 700                  | 2624NO 083631        | 083631               |
|            |                                 | 800                  | 2635NJ 094463        | 094463               |
| 180        | 445                             | 100                  | 2636NE 083658        | 083658               |
|            |                                 | 150                  | 2638NW 094501        | 094501               |
|            |                                 | 200                  | 2639NQ 083666        | 083666               |
|            |                                 | 250                  | 2641NX 094528        | 094528               |
|            |                                 | 300                  | 2642NS 083674        | 083674               |
|            |                                 | 350                  | 2643NN 094536        | 094536               |
|            |                                 | 400                  | 2644NI 083682        | 083682               |
|            |                                 | 500                  | 2645ND 083690        | 083690               |
|            |                                 | 600                  | 2646NZ 083704        | 083704               |
|            |                                 | 700                  | 2647NU 083712        | 083712               |
|            |                                 | 800                  | 2648NP 094544        | 094544               |
| 200        | 485                             | 100                  | 752886 083720        | 083720               |
|            |                                 | 150                  | 752894 094552        | 094552               |
|            |                                 | 200                  | 1432EB 083739        | 083739               |
|            |                                 | 250                  | 752908 094560        | 094560               |

| A          | B                               | Force / Kraft F, [N] | 1                    | 2                    |
|------------|---------------------------------|----------------------|----------------------|----------------------|
| Stroke Hub | Extended length Ausgesch. Länge |                      | Ref.-No. Bestell-Nr. | Ref.-No. Bestell-Nr. |
| 200        | 485                             | 300                  | 1433EX 094579        | 094579               |
|            |                                 | 400                  | 752916 083755        | 083755               |
|            |                                 | 500                  | 752924 083771        | 083771               |
|            |                                 | 700                  | 2649NK 083798        | 083798               |
|            |                                 | 800                  | 2651NR 094587        | 094587               |
| 220        | 525                             | 100                  | 2652NM 083801        | 083801               |
|            |                                 | 150                  | 2653NH 094595        | 094595               |
|            |                                 | 200                  | 2654NC 083828        | 083828               |
|            |                                 | 250                  | 2655NY 094609        | 094609               |
|            |                                 | 300                  | 2656NT 083836        | 083836               |
|            |                                 | 350                  | 2657NO 094617        | 094617               |
|            |                                 | 400                  | 2658NJ 083844        | 083844               |
|            |                                 | 500                  | 2659NE 083852        | 083852               |
|            |                                 | 600                  | 2661NL 083860        | 083860               |
|            |                                 | 700                  | 2662NG 083879        | 083879               |
|            |                                 | 800                  | 2663NB 094625        | 094625               |
| 250        | 585                             | 100                  | 752940 083887        | 083887               |
|            |                                 | 150                  | 752959 094633        | 094633               |
|            |                                 | 200                  | 1435EN 083895        | 083895               |
|            |                                 | 250                  | 752967 094641        | 094641               |
|            |                                 | 300                  | 1436EJ 083909        | 083909               |
|            |                                 | 350                  | 1437ED 094668        | 094668               |
|            |                                 | 400                  | 752975 083917        | 083917               |
|            |                                 | 500                  | 752983 083925        | 083925               |
|            |                                 | 600                  | 752991 083933        | 083933               |
|            |                                 | 700                  | 2664NX 083941        | 083941               |
|            |                                 | 800                  | 2665NS 094676        | 094676               |

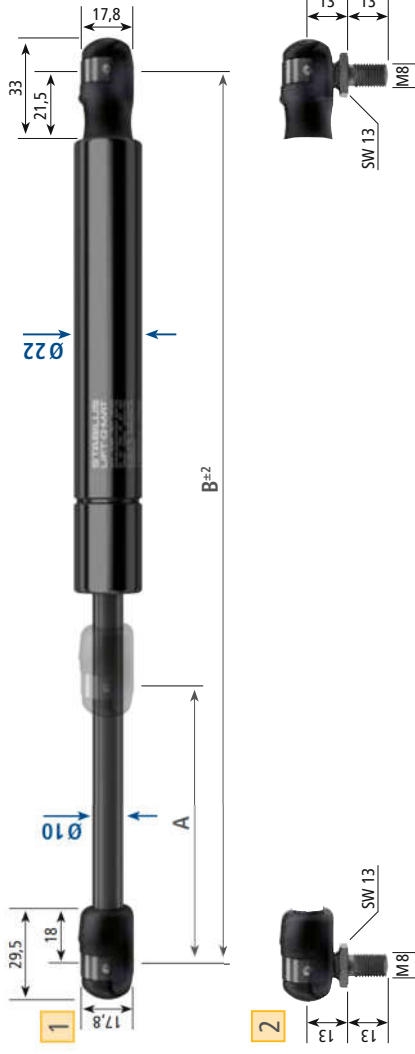

Suitable for ball studs according to DIN 71803 010  
Passend für Kugelzapfen nach DIN 71803 010

| A   | B   | Force / Kraft<br>F <sub>i</sub> [N] | Ref.-No.<br>Bestell-Nr. |
|-----|-----|-------------------------------------|-------------------------|
| 96  | 285 | 900                                 | 084832                  |
|     |     | 1000                                | 084840                  |
|     |     | 1150                                | 094986                  |
| 145 | 385 | 900                                 | 084875                  |
|     |     | 1000                                | 084883                  |
|     |     | 1150                                | 094994                  |
| 196 | 485 | 900                                 | 084913                  |
|     |     | 1000                                | 084921                  |
|     |     | 1150                                | 095001                  |
| 246 | 585 | 900                                 | 084964                  |
|     |     | 1000                                | 084972                  |
|     |     | 1150                                | 095028                  |
| 296 | 685 | 150                                 | 095036                  |
|     |     | 200                                 | 095044                  |
|     |     | 250                                 | 095052                  |
|     |     | 300                                 | 095060                  |
|     |     | 350                                 | 095079                  |
|     |     | 400                                 | 095087                  |
|     |     | 500                                 | 095095                  |
|     |     | 600                                 | 095109                  |
|     |     | 700                                 | 084980                  |
|     |     | 800                                 | 084999                  |
|     |     | 900                                 | 085014                  |
|     |     | 1000                                | 085022                  |
|     |     | 1150                                | 097306                  |

| A   | B   | Force / Kraft<br>F <sub>i</sub> [N] | Ref.-No.<br>Bestell-Nr. |
|-----|-----|-------------------------------------|-------------------------|
| 346 | 785 | 150                                 | 095117                  |
|     |     | 200                                 | 095125                  |
|     |     | 250                                 | 095133                  |
|     |     | 300                                 | 095141                  |
|     |     | 350                                 | 095176                  |
|     |     | 400                                 | 095168                  |
|     |     | 500                                 | 095184                  |
|     |     | 600                                 | 095192                  |
|     |     | 700                                 | 085030                  |
|     |     | 800                                 | 085049                  |
|     |     | 900                                 | 085057                  |
|     |     | 1000                                | 085065                  |
| 396 | 885 | 150                                 | 095214                  |
|     |     | 200                                 | 095222                  |
|     |     | 250                                 | 095230                  |
|     |     | 300                                 | 095249                  |
|     |     | 350                                 | 095257                  |
|     |     | 400                                 | 095265                  |
|     |     | 500                                 | 095273                  |
|     |     | 600                                 | 095281                  |
|     |     | 700                                 | 085073                  |
|     |     | 800                                 | 086401                  |

| A   | B   | Force / Kraft<br>F <sub>i</sub> [N] | Ref.-No.<br>Bestell-Nr. | 1      | 2      |
|-----|-----|-------------------------------------|-------------------------|--------|--------|
| 100 | 285 | 900                                 | 2666NN                  | 085146 | 085146 |
|     |     | 1000                                | 2667NI                  | 085154 | 085154 |
|     |     | 1150                                | 2668ND                  | 095303 | 095303 |
| 150 | 385 | 900                                 | 2669NZ                  | 085189 | 085189 |
|     |     | 1000                                | 2671NF                  | 085197 | 085197 |
|     |     | 1150                                | 2672NA                  | 095311 | 095311 |
| 200 | 485 | 700                                 | 1442EW                  | 497614 | 497614 |
|     |     | 800                                 | 1443ER                  | 232785 | 232785 |
|     |     | 900                                 | 1444EM                  | 085227 | 085227 |
|     |     | 1000                                | 1445EH                  | 085235 | 085235 |
|     |     | 1150                                | 2673NW                  | 095338 | 095338 |
| 250 | 585 | 700                                 | 1446EC                  | 292001 | 292001 |
|     |     | 800                                 | 1447EY                  | 303925 | 303925 |
|     |     | 900                                 | 1448ET                  | 085278 | 085278 |
|     |     | 1000                                | 1449EO                  | 085286 | 085286 |
|     |     | 1150                                | 2674NR                  | 095346 | 095346 |
| 300 | 685 | 150                                 | 2675NM                  | 095354 | 095354 |
|     |     | 200                                 | 3935LP                  | 095362 | 095362 |
|     |     | 250                                 | 1438EZ                  | 095370 | 095370 |
|     |     | 300                                 | 2677NC                  | 095389 | 095389 |
|     |     | 350                                 | 1652CK                  | 095397 | 095397 |
|     |     | 400                                 | 753009                  | 095400 | 095400 |
|     |     | 500                                 | 2679NT                  | 095419 | 095419 |
|     |     | 600                                 | 2682NV                  | 095427 | 095427 |
|     |     | 700                                 | 753017                  | 085294 | 085294 |
|     |     | 800                                 | 2683NQ                  | 085308 | 085308 |
|     |     | 900                                 | 753025                  | 085316 | 085316 |
|     |     | 1000                                | 753033                  | 085324 | 085324 |
|     |     | 1150                                | 2684NL                  | 095435 | 095435 |

| A   | B   | Force / Kraft<br>F <sub>i</sub> [N] | Ref.-No.<br>Bestell-Nr. | 1      | 2      |
|-----|-----|-------------------------------------|-------------------------|--------|--------|
| 350 | 785 | 150                                 | 2685NG                  | 095443 | 095443 |
|     |     | 200                                 | 2686NB                  | 095451 | 095451 |
|     |     | 250                                 | 1439EU                  | 095478 | 095478 |
|     |     | 300                                 | 2687NX                  | 095486 | 095486 |
|     |     | 350                                 | 2688NS                  | 095494 | 095494 |
|     |     | 400                                 | 753041                  | 095508 | 095508 |
|     |     | 500                                 | 2689NN                  | 095516 | 095516 |
|     |     | 600                                 | 2691NU                  | 095524 | 095524 |
|     |     | 700                                 | 753068                  | 085332 | 085332 |
|     |     | 800                                 | 2692NP                  | 085340 | 085340 |
|     |     | 900                                 | 753076                  | 085359 | 085359 |
|     |     | 1000                                | 753084                  | 085367 | 085367 |
| 400 | 885 | 150                                 | 2694NF                  | 095540 | 095540 |
|     |     | 200                                 | 2695NA                  | 095559 | 095559 |
|     |     | 250                                 | 1441EA                  | 095567 | 095567 |
|     |     | 300                                 | 2696NW                  | 095575 | 095575 |
|     |     | 350                                 | 2697NR                  | 095583 | 095583 |
|     |     | 400                                 | 753092                  | 095591 | 095591 |
|     |     | 500                                 | 2698NM                  | 095605 | 095605 |
|     |     | 600                                 | 2699NH                  | 095613 | 095613 |
|     |     | 700                                 | 753106                  | 085375 | 085375 |
|     |     | 800                                 | 2701NN                  | 085383 | 085383 |



Suitable for ball studs according to DIN 71803 016  
 Passend für Kugelzapfen nach DIN 71803 016

| A   | B   | Force / Kraft<br>F <sub>i</sub> [N] | Ref.-No.<br>Bestell-Nr. |
|-----|-----|-------------------------------------|-------------------------|
| 100 | 302 | 1300                                | 1847LW                  |
|     |     | 1500                                | 2038LR                  |
|     |     | 1700                                | 2039IM                  |
|     |     | 1900                                | 2041LT                  |
|     |     | 2100                                | 2042LO                  |
| 150 | 402 | 1300                                | 1851IT                  |
|     |     | 1500                                | 2043LJ                  |
|     |     | 1700                                | 2044LE                  |
|     |     | 1900                                | 2046IV                  |
|     |     | 2100                                | 2047LQ                  |
| 200 | 502 | 1300                                | 1854LE                  |
|     |     | 1500                                | 2048LL                  |
|     |     | 1700                                | 2049LG                  |
|     |     | 1900                                | 2051LN                  |
|     |     | 2100                                | 2052LU                  |
| 250 | 602 | 1300                                | 1858LL                  |
|     |     | 1500                                | 2055LU                  |
|     |     | 1700                                | 2056LP                  |
|     |     | 1900                                | 2057LK                  |
|     |     | 2100                                | 2058LF                  |
| 300 | 702 | 1300                                | 1862LU                  |
|     |     | 1500                                | 2059JA                  |
|     |     | 1700                                | 2061LH                  |
|     |     | 1900                                | 2062LC                  |
|     |     | 2100                                | 2063LY                  |

| A   | B    | Force / Kraft<br>F <sub>i</sub> [N] | Ref.-No.<br>Bestell-Nr. |
|-----|------|-------------------------------------|-------------------------|
| 350 | 802  | 1300                                | 1865LU                  |
|     |      | 1500                                | 2064LT                  |
|     |      | 1700                                | 2065LO                  |
|     |      | 1900                                | 2066LJ                  |
|     |      | 2100                                | 2067LE                  |
| 400 | 902  | 1300                                | 1868IF                  |
|     |      | 1500                                | 2069LV                  |
|     |      | 1700                                | 2071LB                  |
|     |      | 1900                                | 2072LX                  |
|     |      | 2100                                | 2073LS                  |
| 500 | 1102 | 500                                 | 1872LC                  |
|     |      | 600                                 | 2108LB                  |
|     |      | 700                                 | 2109LX                  |
|     |      | 800                                 | 2111LD                  |
|     |      | 900                                 | 2112LZ                  |
|     |      | 1000                                | 2113LU                  |
|     |      | 1100                                | 2114LP                  |
|     |      | 1300                                | 2115LK                  |
|     |      | 1500                                | 2116LF                  |
|     |      | 1700                                | 2117LA                  |
|     |      | 1900                                | 2118LW                  |

| A   | B     | Force / Kraft<br>F <sub>i</sub> [N] | Ref.-No.<br>Bestell-Nr. |
|-----|-------|-------------------------------------|-------------------------|
| 100 | 335,5 | 1300                                | 2029LS                  |
|     |       | 1500                                | 2357LQ                  |
|     |       | 1700                                | 2358LI                  |
|     |       | 1900                                | 2359LG                  |
|     |       | 2100                                | 2361LN                  |
| 150 | 435,5 | 1300                                | 2033IP                  |
|     |       | 1500                                | 2362LI                  |
|     |       | 1700                                | 2363LD                  |
|     |       | 1900                                | 2364LZ                  |
|     |       | 2100                                | 2365LU                  |
| 200 | 535,5 | 1300                                | 2036LA                  |
|     |       | 1500                                | 2366IP                  |
|     |       | 1700                                | 2367LK                  |
|     |       | 1900                                | 2368LF                  |
|     |       | 2100                                | 2369LA                  |
| 250 | 635,5 | 1300                                | 2075LI                  |
|     |       | 1500                                | 2371LH                  |
|     |       | 1700                                | 2372LC                  |
|     |       | 1900                                | 2373LY                  |
|     |       | 2100                                | 2374LT                  |
| 300 | 735,5 | 1300                                | 2078LU                  |
|     |       | 1500                                | 2375LO                  |
|     |       | 1700                                | 2376LJ                  |
|     |       | 1900                                | 2377LE                  |
|     |       | 2100                                | 2379LV                  |

| A   | B      | Force / Kraft<br>F <sub>i</sub> [N] | Ref.-No.<br>Bestell-Nr. |
|-----|--------|-------------------------------------|-------------------------|
| 350 | 835,5  | 1300                                | 2082LR                  |
|     |        | 1500                                | 2381LB                  |
|     |        | 1700                                | 2382LX                  |
|     |        | 1900                                | 2383LS                  |
|     |        | 2100                                | 2384LN                  |
| 400 | 935,5  | 1300                                | 2085LC                  |
|     |        | 1500                                | 2385LI                  |
|     |        | 1700                                | 2386LD                  |
|     |        | 1900                                | 2387LZ                  |
|     |        | 2100                                | 2388LU                  |
| 500 | 1135,5 | 500                                 | 2088LO                  |
|     |        | 600                                 | 2389LP                  |
|     |        | 700                                 | 2391LW                  |
|     |        | 800                                 | 2392LR                  |
|     |        | 900                                 | 2393LM                  |
|     |        | 1000                                | 2394LH                  |
|     |        | 1100                                | 2395LC                  |
|     |        | 1300                                | 2396LY                  |
|     |        | 1500                                | 2397LT                  |
|     |        | 1700                                | 2398LO                  |



| A          |                                 | B                                |                      |            |                                 |
|------------|---------------------------------|----------------------------------|----------------------|------------|---------------------------------|
| Stroke Hub | Extended length Ausgesch. Länge | Force / Kraft F <sub>i</sub> [N] | Ref.-No. Bestell-Nr. | Stroke Hub | Extended length Ausgesch. Länge |
| 150        | 500                             | 2400                             | 095974               | 200        | 600                             |
|            |                                 | 2800                             | 095982               |            |                                 |
|            |                                 | 3200                             | 207519               |            |                                 |
|            |                                 | 3600                             | 207527               |            |                                 |
|            |                                 | 4000                             | 155624               |            |                                 |
|            |                                 | 4600                             | 207535               |            |                                 |
|            |                                 | 5200                             | 207543               |            |                                 |
| 200        | 600                             | 2400                             | 086657               | 250        | 700                             |
|            |                                 | 2800                             | 086665               |            |                                 |
|            |                                 | 3200                             | 207462               |            |                                 |
|            |                                 | 3600                             | 207470               |            |                                 |
|            |                                 | 4000                             | 207489               |            |                                 |
|            |                                 | 4600                             | 207497               |            |                                 |
|            |                                 | 5200                             | 207500               |            |                                 |
| 250        | 700                             | 2400                             | 086738               | 300        | 800                             |
|            |                                 | 2800                             | 086746               |            |                                 |
|            |                                 | 3200                             | 207551               |            |                                 |
|            |                                 | 3600                             | 207578               |            |                                 |
|            |                                 | 4000                             | 207586               |            |                                 |
|            |                                 | 4600                             | 207594               |            |                                 |
|            |                                 | 5200                             | 207608               |            |                                 |
| 300        | 800                             | 2400                             | 086789               |            |                                 |
|            |                                 | 2800                             | 086800               |            |                                 |
|            |                                 | 3200                             | 207616               |            |                                 |
|            |                                 | 3600                             | 207624               |            |                                 |
|            |                                 | 4000                             | 207632               |            |                                 |
|            |                                 | 4600                             | 207640               |            |                                 |
|            |                                 | 5200                             | 207659               |            |                                 |



| A          |                                 | B                                |                      |            |                                 |
|------------|---------------------------------|----------------------------------|----------------------|------------|---------------------------------|
| Stroke Hub | Extended length Ausgesch. Länge | Force / Kraft F <sub>i</sub> [N] | Ref.-No. Bestell-Nr. | Stroke Hub | Extended length Ausgesch. Länge |
| 150        | 520                             | 2400                             | 087041               | 200        | 620                             |
|            |                                 | 2800                             | 087068               |            |                                 |
|            |                                 | 3200                             | 207829               |            |                                 |
|            |                                 | 3600                             | 207837               |            |                                 |
|            |                                 | 4000                             | 207845               |            |                                 |
|            |                                 | 4600                             | 207853               |            |                                 |
|            |                                 | 5200                             | 207861               |            |                                 |
| 200        | 620                             | 2400                             | 087114               | 250        | 720                             |
|            |                                 | 2800                             | 087122               |            |                                 |
|            |                                 | 3200                             | 207888               |            |                                 |
|            |                                 | 3600                             | 207896               |            |                                 |
|            |                                 | 4000                             | 207918               |            |                                 |
|            |                                 | 4600                             | 207926               |            |                                 |
|            |                                 | 5200                             | 207934               |            |                                 |
| 250        | 720                             | 2400                             | 087173               | 300        | 820                             |
|            |                                 | 2800                             | 087181               |            |                                 |
|            |                                 | 3200                             | 207942               |            |                                 |
|            |                                 | 3600                             | 207950               |            |                                 |
|            |                                 | 4000                             | 207969               |            |                                 |
|            |                                 | 4600                             | 207977               |            |                                 |
|            |                                 | 5200                             | 207985               |            |                                 |
| 300        | 820                             | 2400                             | 087254               |            |                                 |
|            |                                 | 2800                             | 087262               |            |                                 |
|            |                                 | 3200                             | 207993               |            |                                 |
|            |                                 | 3600                             | 208000               |            |                                 |
|            |                                 | 4000                             | 208019               |            |                                 |
|            |                                 | 4600                             | 208027               |            |                                 |
|            |                                 | 5200                             | 208035               |            |                                 |

| A          |                                 | B                                |                      |            |                                 |
|------------|---------------------------------|----------------------------------|----------------------|------------|---------------------------------|
| Stroke Hub | Extended length Ausgesch. Länge | Force / Kraft F <sub>i</sub> [N] | Ref.-No. Bestell-Nr. | Stroke Hub | Extended length Ausgesch. Länge |
| 350        | 920                             | 2400                             | 087319               | 400        | 1020                            |
|            |                                 | 2800                             | 087327               |            |                                 |
|            |                                 | 3200                             | 208043               |            |                                 |
|            |                                 | 3600                             | 208051               |            |                                 |
|            |                                 | 4000                             | 208078               |            |                                 |
|            |                                 | 4600                             | 208086               |            |                                 |
|            |                                 | 5200                             | 208094               |            |                                 |
| 400        | 1020                            | 2400                             | 087386               | 500        | 1220                            |
|            |                                 | 2800                             | 087394               |            |                                 |
|            |                                 | 3200                             | 208108               |            |                                 |
|            |                                 | 3600                             | 208116               |            |                                 |
|            |                                 | 4000                             | 208124               |            |                                 |
|            |                                 | 4600                             | 208132               |            |                                 |
|            |                                 | 5200                             | 208140               |            |                                 |
| 500        | 1220                            | 2400                             | 087440               |            |                                 |
|            |                                 | 2800                             | 087459               |            |                                 |
|            |                                 | 3200                             | 208159               |            |                                 |
|            |                                 | 3600                             | 208167               |            |                                 |
|            |                                 | 4000                             | 208175               |            |                                 |
|            |                                 | 4600                             | 208183               |            |                                 |
|            |                                 | 5200                             | 208191               |            |                                 |



## Dynamic extension damping

The LIFT-O-MAT DD with dynamic damping is a gas spring whose damping properties and extension speed is controlled primarily through a longitudinal groove in the pressure cylinder.

By reducing or increasing the groove cross-section, the piston rod's speed can be varied over the entire stroke, allowing it to be customized to the application. The motion can be slowed down smoothly and continuously until it comes to a stop. It allows implementing different compression and extension characteristics as well as a damped approach of intermediate positions.

The LIFT-O-MAT DD works regardless of its orientation, while approaching any position smoothly, without stressing hinges and joints.

### Advantages

- Orientation-independent damping
- Definable speed control
- Great tunability of damping characteristics

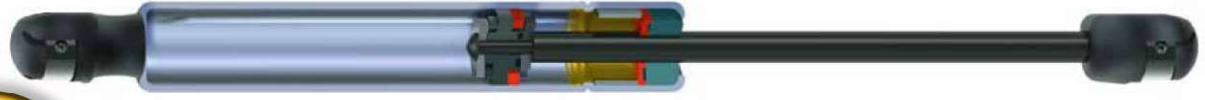

Groove  
Nut

Damping range  
Dämpfstrecke



Suitable for ball studs according to DIN 71803 010  
Passend für Kugelzapfen nach DIN 71803 010

| A   | B   | Force / Kraft<br>$F_1$ [N] | Ref. No.<br>Bestell-Nr. |
|-----|-----|----------------------------|-------------------------|
| 100 | 285 | 100                        | 989233                  |
|     |     | 150                        | 992579                  |
|     |     | 200                        | 992818                  |
|     |     | 250                        | 993057                  |
|     |     | 300                        | 993296                  |
|     |     | 350                        | 993535                  |
|     |     | 400                        | 994013                  |
|     |     | 500                        | 994252                  |
|     |     | 600                        | 994491                  |
| 120 | 325 | 100                        | 04794                   |
|     |     | 150                        | 04467                   |
|     |     | 200                        | 04706                   |
|     |     | 250                        | 04945                   |
|     |     | 300                        | 045184                  |
|     |     | 350                        | 045423                  |
|     |     | 400                        | 045662                  |
|     |     | 500                        | 045901                  |
|     |     | 600                        | 046379                  |
| 140 | 365 | 100                        | 048530                  |
|     |     | 150                        | 068367                  |
|     |     | 200                        | 068606                  |
|     |     | 250                        | 069084                  |
|     |     | 300                        | 069323                  |
|     |     | 350                        | 069562                  |
|     |     | 400                        | 069801                  |
|     |     | 500                        | 070040                  |
|     |     | 600                        | 070279                  |
| 160 | 405 | 100                        | 072191                  |
|     |     | 150                        | 072908                  |
|     |     | 200                        | 073864                  |
|     |     | 250                        | 074103                  |
|     |     | 300                        | 074342                  |
|     |     | 350                        | 074581                  |
|     |     | 400                        | 074820                  |
|     |     | 500                        | 075059                  |
|     |     | 600                        | 075298                  |

| A   | B   | Force / Kraft<br>$F_1$ [N] | Ref. No.<br>Bestell-Nr. |
|-----|-----|----------------------------|-------------------------|
| 180 | 445 | 100                        | 081273                  |
|     |     | 150                        | 081512                  |
|     |     | 200                        | 081751                  |
|     |     | 250                        | 083424                  |
|     |     | 300                        | 083663                  |
|     |     | 350                        | 083902                  |
|     |     | 400                        | 084141                  |
|     |     | 500                        | 084380                  |
|     |     | 600                        | 084619                  |
| 200 | 485 | 100                        | 085336                  |
|     |     | 150                        | 094896                  |
|     |     | 200                        | 095135                  |
|     |     | 250                        | 095374                  |
|     |     | 300                        | 095852                  |
|     |     | 350                        | 096330                  |
|     |     | 400                        | 096569                  |
|     |     | 500                        | 096808                  |
|     |     | 600                        | 097286                  |
| 220 | 525 | 100                        | 101588                  |
|     |     | 150                        | 101827                  |
|     |     | 200                        | 102066                  |
|     |     | 250                        | 102305                  |
|     |     | 300                        | 102544                  |
|     |     | 350                        | 102783                  |
|     |     | 400                        | 103022                  |
|     |     | 500                        | 103261                  |
|     |     | 600                        | 103739                  |
| 250 | 585 | 100                        | 105173                  |
|     |     | 150                        | 105412                  |
|     |     | 200                        | 105890                  |
|     |     | 250                        | 106179                  |
|     |     | 300                        | 106368                  |
|     |     | 350                        | 106846                  |
|     |     | 400                        | 107324                  |
|     |     | 500                        | 107563                  |
|     |     | 600                        | 108519                  |

## Dynamisch ausschubgedämpft

Der LIFT-O-MAT DD mit dynamischer Dämpfung ist eine Gasfeder, deren Dämpfungseigenschaften und die Steuerung der Ausschubgeschwindigkeit im Wesentlichen durch eine Längsnut im Druckrohr definiert werden. Durch entsprechende Erweiterung bzw. Verringerung des Nutquerschnittes lässt sich über den gesamten Hub die Bewegungsgeschwindigkeit der Kobenstange beliebig festlegen und somit in idealer Weise an die jeweilige Anwendung anpassen. Der Bewegungsvorgang kann so harmonisch und kontinuierlich bis zum annähernden Stillstand verringert werden. Eine unterschiedliche Ein- und Ausschubcharakteristik ist ebenso realisierbar wie gedämpfte

Anfahren von Zwischenpositionen. Der LIFT-O-MAT DD funktioniert lageunabhängig und bewirkt ein komfortables, scharnier- bzw. gelenkschonendes Anfahren der gewünschten Position.

### Vorteile

- Lageunabhängige Dämpfung
- Definierte Geschwindigkeitssteuerung
- Große Einflussmöglichkeit auf die Dämpfungscharakteristik





CAD-Configurator  
CAD-Konfigurator



stabilus.cadclick.com

For each of our gas springs and dampers, there are numerous potential variants. Use them to configure the product variant that meets your requirements. Our options are almost endless.

Choose from different strokes, lengths, diameters and different fittings made from metal or plastic (K1 - K7 and D1 - D7). Force can also be selected individually. Optional guard or locking tubes (S1 or S2) are also available.

You can use our online CAD-Configurator to render your 3D model and your 2D drawing.

Für jede unserer Gasfedern und Dämpfer sind unzählige Varianten möglich. Konfigurieren Sie daraus eine Ihren Bedürfnissen entsprechende Produktvariante. Unseren Möglichkeiten sind fast keine Grenzen gesetzt.

Wählen Sie zwischen verschiedenen Hüben, Längen, Durchmessern und unterschiedlichen Anschlüssen aus Metall oder Kunststoff (K1 - K7 und D1 - D7). Auch die F<sub>1</sub>-Kraft ist individuell wählbar. Optional haben Sie zudem die Möglichkeit ein Schutz- oder Arretierrohr (S1 oder S2) auszuwählen.

Nutzen Sie dazu auch unseren Online-CAD-Konfigurator zur Visualisierung Ihres ausgewählten 3D-Modells sowie Ihrer 2D-Zeichnung.

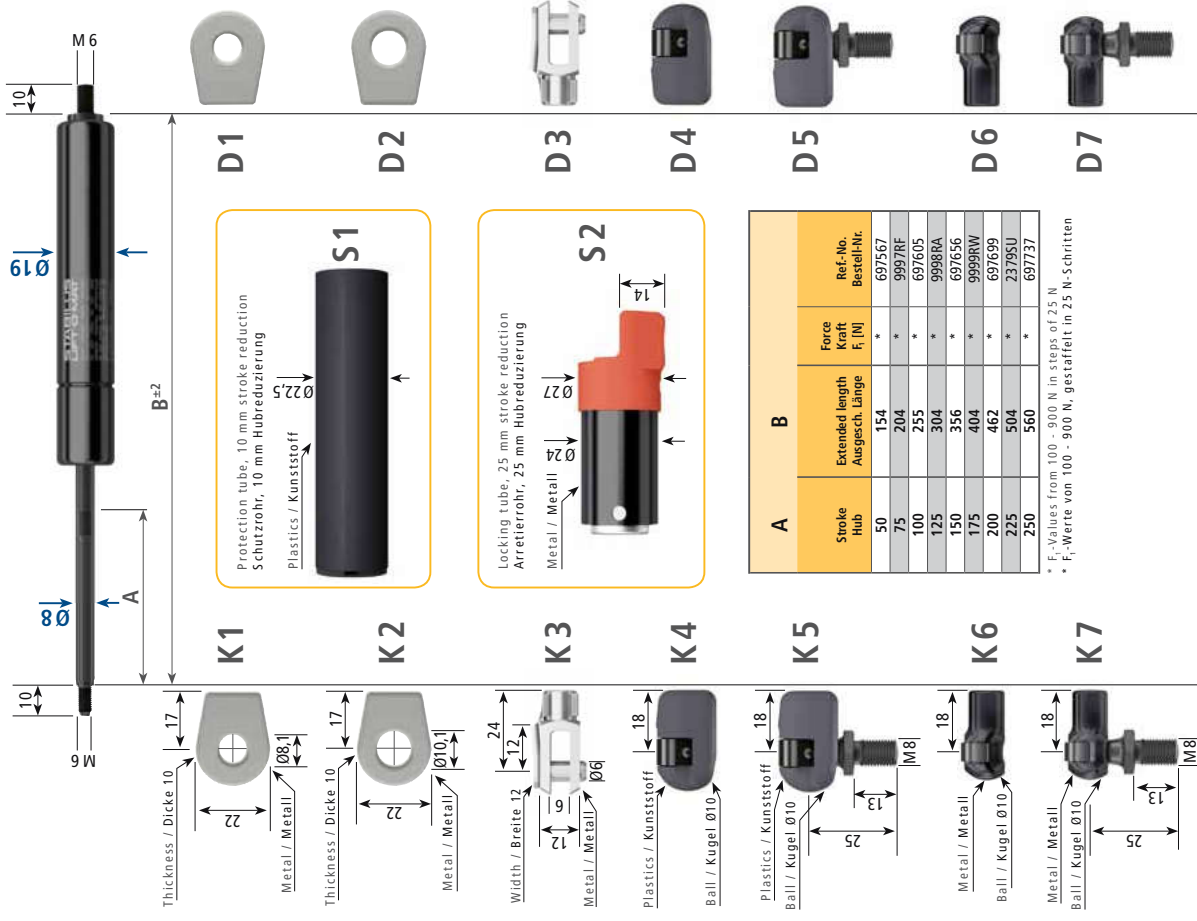

| A      |     | B               |                 | Force | Ref.-No.    |
|--------|-----|-----------------|-----------------|-------|-------------|
| Stroke | Hub | Extended length | Ausgesch. Länge | Kraft | Bestell-Nr. |
| 50     | 75  | 154             | 204             | *     | 697567      |
| 75     | 100 | 204             | 255             | *     | 99979F      |
| 100    | 125 | 255             | 304             | *     | 697605      |
| 125    | 150 | 304             | 356             | *     | 99988RA     |
| 150    | 175 | 356             | 404             | *     | 697656      |
| 175    | 200 | 404             | 462             | *     | 99999RW     |
| 200    | 225 | 462             | 504             | *     | 697699      |
| 225    | 250 | 504             | 560             | *     | 23795U      |
| 250    |     | 560             |                 | *     | 697737      |

\* F<sub>1</sub>-Values from 100 - 900 N in steps of 25 N  
\* F<sub>1</sub>-Werte von 100 - 900 N, gestaffelt in 25 N-Schritten

Ordering example / Bestell-Beispiel

|             |   |                |   |                         |   |                           |   |                 |
|-------------|---|----------------|---|-------------------------|---|---------------------------|---|-----------------|
| 123456      | / | 0350N          | / | K2                      | / | D1                        | / | S1              |
| Ref.-No.    |   | F <sub>1</sub> |   | Piston rod end fitting  |   | Pressure tube end fitting |   | Optional tube   |
| Bestell-Nr. |   |                |   | Kolbenstangen-Anschluss |   | Druckrohr-Anschluss       |   | Optionales Rohr |

Installation according to STAB-Spec. 10005630 / Montage nach STAB-Spec. 10005630

We reserve the right to make modifications. Dimensions in mm. Änderungen vorbehalten. Maßangaben in mm.



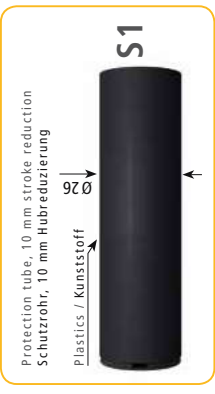
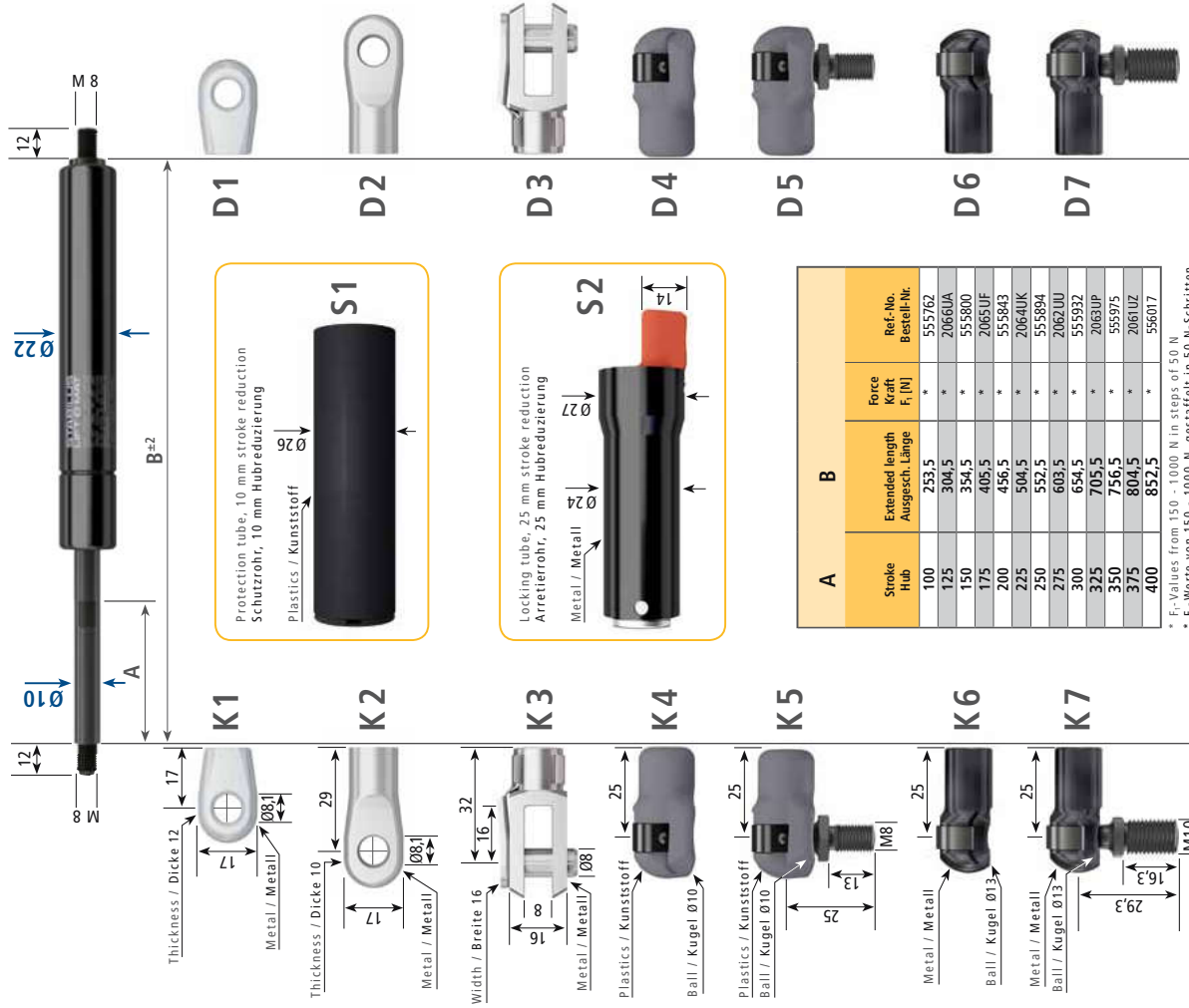

| A             |                                    | B                                    |        | Ref.-No.<br>Bestell-Nr. |
|---------------|------------------------------------|--------------------------------------|--------|-------------------------|
| Stroke<br>Hub | Extended length<br>Ausgesch. Länge | Force<br>Kraft<br>F <sub>i</sub> [N] |        |                         |
| 100           | 253,5                              | *                                    | 555762 |                         |
| 125           | 304,5                              | *                                    | 20661A |                         |
| 150           | 354,5                              | *                                    | 555800 |                         |
| 175           | 405,5                              | *                                    | 20650F |                         |
| 200           | 456,5                              | *                                    | 555843 |                         |
| 225           | 504,5                              | *                                    | 20640K |                         |
| 250           | 552,5                              | *                                    | 555894 |                         |
| 275           | 603,5                              | *                                    | 20621U |                         |
| 300           | 654,5                              | *                                    | 555932 |                         |
| 325           | 705,5                              | *                                    | 20630P |                         |
| 350           | 756,5                              | *                                    | 555975 |                         |
| 375           | 804,5                              | *                                    | 20610Z |                         |
| 400           | 852,5                              | *                                    | 556017 |                         |

\* F<sub>i</sub>-Values from 150 - 1000 N in steps of 50 N  
\* F<sub>i</sub>-Werte von 150 - 1000 N, gestaffelt in 50 N-Schritten

**Ordering example / Bestell-Beispiel**

|                         |   |                |   |   |   |  |   |                                  |
|-------------------------|---|----------------|---|---|---|--|---|----------------------------------|
| 123456                  | / | 0350N          | / | K2  | / | D1   | / | S1                               |
| Ref.-No.<br>Bestell-Nr. |   | F <sub>1</sub> |   | Piston rod end fitting<br>Kolbenstangen-Anschluss |   | Pressure tube end fitting<br>Druckrohr-Anschluss |   | Optional tube<br>Optionales Rohr |

Installation according to STAB-Spec. 10005625 / Montage nach STAB-Spec. 10005625

We reserve the right to make modifications. Dimensions in mm.  
Änderungen vorbehalten. Maßangaben in mm.

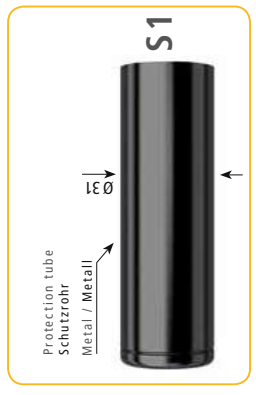
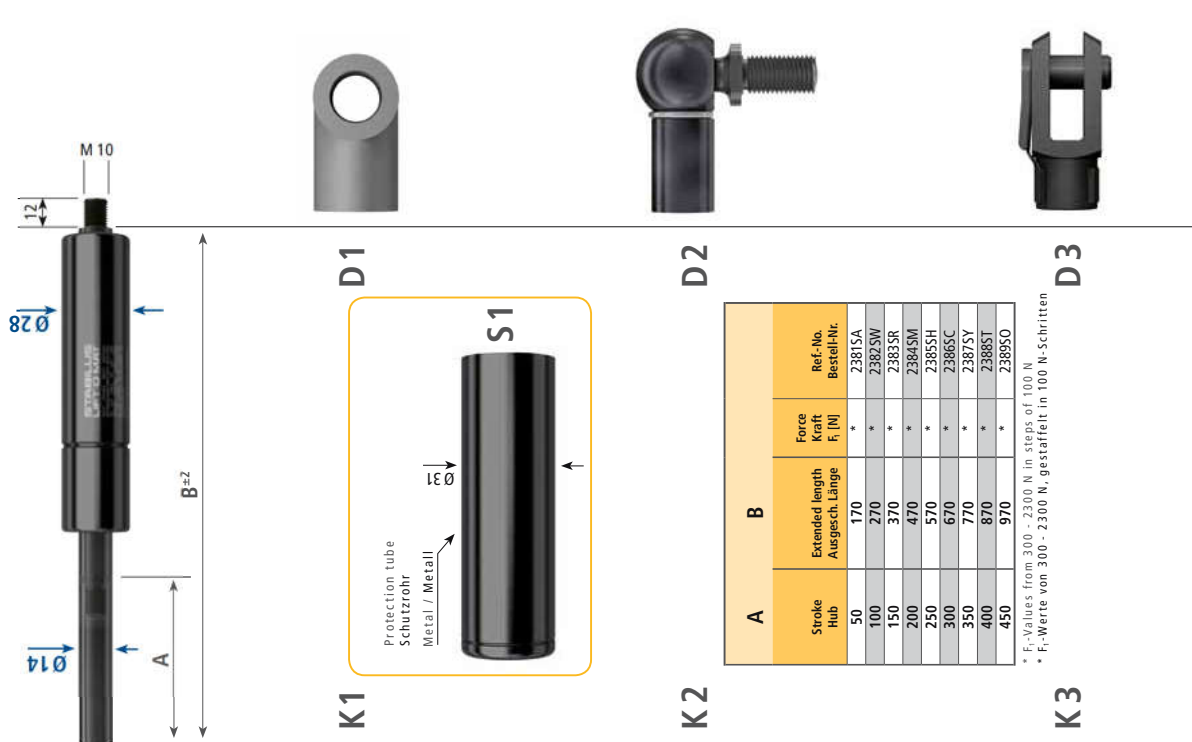

| A             |                                    | B                                    |        | Ref.-No.<br>Bestell-Nr. |
|---------------|------------------------------------|--------------------------------------|--------|-------------------------|
| Stroke<br>Hub | Extended length<br>Ausgesch. Länge | Force<br>Kraft<br>F <sub>i</sub> [N] |        |                         |
| 50            | 170                                | *                                    | 2381SA |                         |
| 100           | 270                                | *                                    | 2382SW |                         |
| 150           | 370                                | *                                    | 2383SR |                         |
| 200           | 470                                | *                                    | 2384SM |                         |
| 250           | 570                                | *                                    | 2385SH |                         |
| 300           | 670                                | *                                    | 2386SC |                         |
| 350           | 770                                | *                                    | 2387SY |                         |
| 400           | 870                                | *                                    | 2388ST |                         |
| 450           | 970                                | *                                    | 2389SO |                         |

\* F<sub>i</sub>-Values from 300 - 2300 N in steps of 100 N  
\* F<sub>i</sub>-Werte von 300 - 2300 N, gestaffelt in 100 N-Schritten

**Ordering example / Bestell-Beispiel**

|                         |   |                |   |   |   |  |   |                                  |
|-------------------------|---|----------------|---|---|---|--|---|----------------------------------|
| 123456                  | / | 0350N          | / | K2  | / | D1   | / | S1                               |
| Ref.-No.<br>Bestell-Nr. |   | F <sub>1</sub> |   | Piston rod end fitting<br>Kolbenstangen-Anschluss |   | Pressure tube end fitting<br>Druckrohr-Anschluss |   | Optional tube<br>Optionales Rohr |

Installation according to STAB-Spec. 10021385 / Montage nach STAB-Spec. 10021385

We reserve the right to make modifications. Dimensions in mm.  
Änderungen vorbehalten. Maßangaben in mm.



## Self-locking in compressed position

The LIFT-O-MAT PTL from Stabilus is a hydraulically damped gas spring with an additional mechanical lock in the compressed position.

Similar to the ballpoint pen principle, the lock can be released by a light push on the gas spring; the gas spring will then automatically extend with damping.

In addition to the force assist function, the LIFT-O-MAT PTL features an end position lock, eliminating the need for installing additional locking elements. At the same time, it is easy and convenient to use.

This gas spring is used in numerous applications, especially in commercial furniture, temporary designer and functional furniture.

### Advantages

- Locking in compressed position
- End position lock without additional locking elements
- Simple release of the lock using the ballpoint pen principle
- User-friendly, convenient operation
- Maintenance-free

Locked in compressed position  
Eingeschoben arretiert

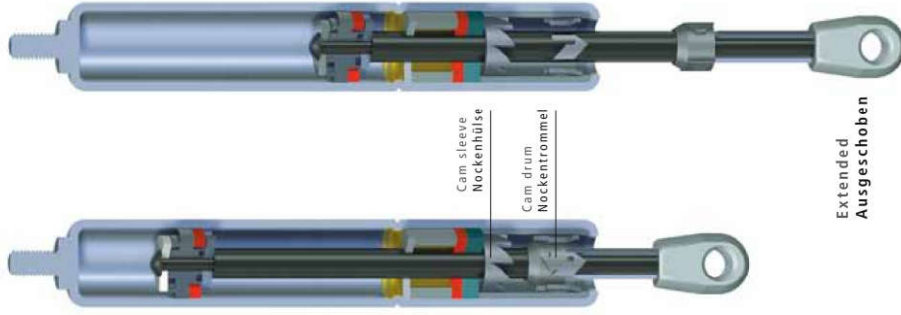

Extended  
Ausgeschoben

## Mit Selbstarretierung in eingeschobener Position

Der LIFT-O-MAT PTL von Stabilus ist eine hydraulisch gedämpfte Gasfeder, die zusätzlich in eingeschobener Lage mechanisch arretiert werden kann.

Ähnlich dem Kugelschreiberprinzip kann die Arretierung durch leichtes Zusammendrücken der Gasfeder gelöst werden, diese fährt dann selbstständig und gedämpft wieder aus.

Neben der Kraftunterstützung verfügt der LIFT-O-MAT PTL über eine Endlagenarretierung, die den Verbau zusätzlicher Fixierelemente erspart. Gleichzeitig bietet er eine äußerst anwenderfreundliche, komfortable Bedienung.

Zum Einsatz kommt diese Gasfeder in zahlreichen Anwendungen, vor allem in modernen, innovativen Designer- und Funktionsmöbeln.

### Vorteile

- Arretieren in eingeschobener Position
- Endlagenarretierung ohne zusätzliche Fixierelemente
- Einfaches Lösen der Arretierung durch Kugelschreiberprinzip
- Anwenderfreundliche, komfortable Bedienung
- Wartungsfrei

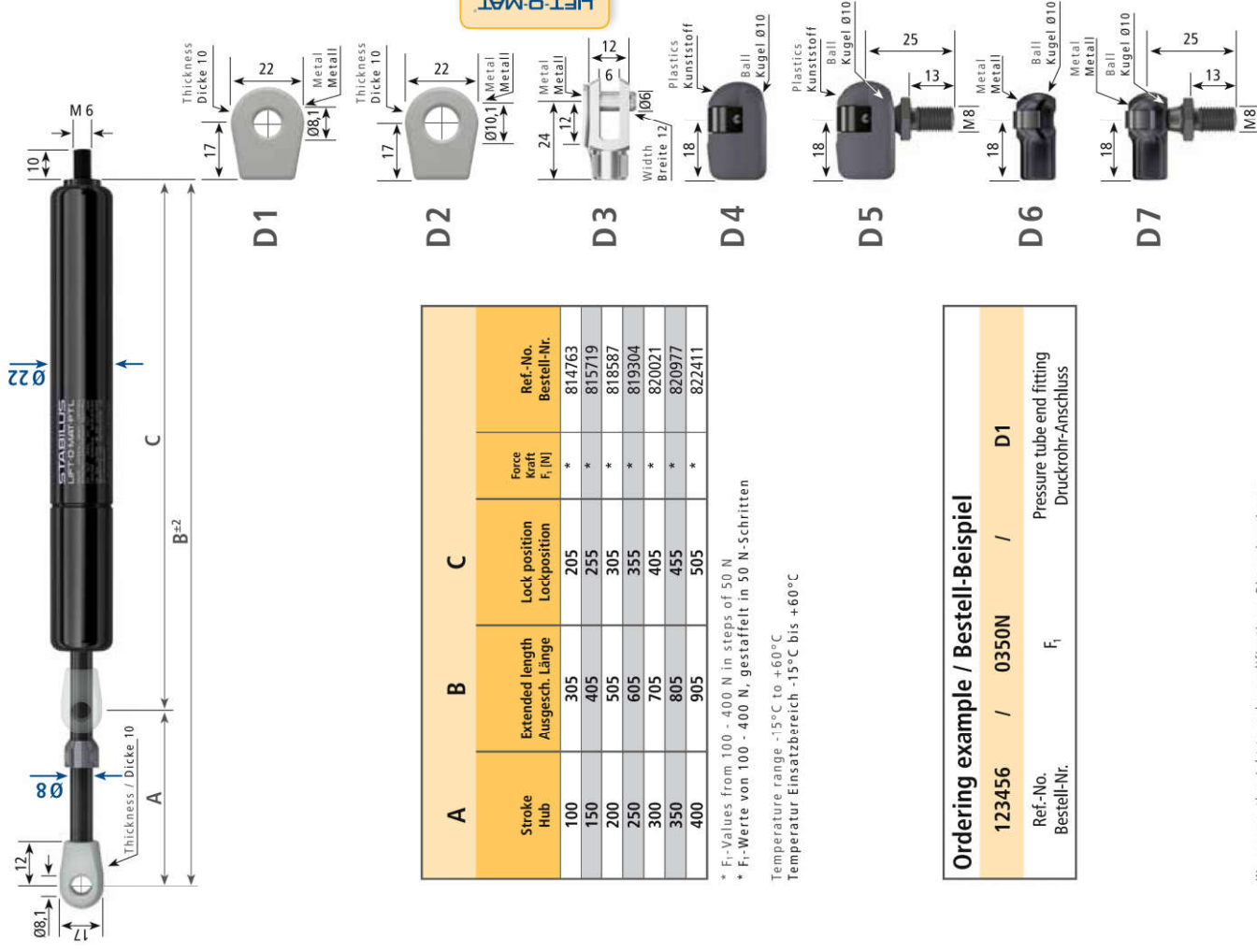

| A             | B                                  | C                             | Force<br>Kraft<br>F <sub>1</sub> [N] | Ref.-No.<br>Bestell-Nr. |
|---------------|------------------------------------|-------------------------------|--------------------------------------|-------------------------|
| Stroke<br>Hub | Extended length<br>Ausgesch. Länge | Lock position<br>Lockposition |                                      |                         |
| 100           | 305                                | 205                           | *                                    | 814763                  |
| 150           | 405                                | 255                           | *                                    | 815719                  |
| 200           | 505                                | 305                           | *                                    | 818587                  |
| 250           | 605                                | 355                           | *                                    | 819304                  |
| 300           | 705                                | 405                           | *                                    | 820021                  |
| 350           | 805                                | 455                           | *                                    | 820977                  |
| 400           | 905                                | 505                           | *                                    | 822411                  |

\* F<sub>1</sub>-Values from 100 - 400 N in steps of 50 N

\* F<sub>1</sub>-Werte von 100 - 400 N, gestaffelt in 50 N-Schritten

Temperatur Einsatzbereich -15°C to +60°C

Temperatur Einsatzbereich -15°C bis +60°C

### Ordering example / Bestell-Beispiel

|                         |   |                |   |  |
|-------------------------|---|----------------|---|--|
| 123456                  | / | 0350N          | / | D1   |
| Ref.-No.<br>Bestell-Nr. |   | F <sub>1</sub> |   | Pressure tube end fitting<br>Druckrohr-Anschluss |

Brackets for gas springs and dampers  
Winkelbleche für Gasfedern und Dämpfer

Part No. / Bestell-Nr. 8262WE  
F<sub>max</sub>\* = 1000 N

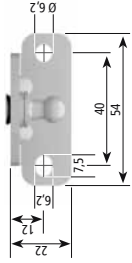

Part No. / Bestell-Nr. 8267WG  
F<sub>max</sub>\* = 700 N

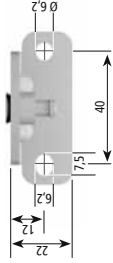

Part No. / Bestell-Nr. 8261WJ  
F<sub>max</sub>\* = 1000 N

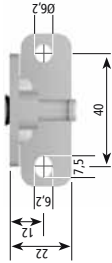

Part No. / Bestell-Nr. 8268WB  
F<sub>max</sub>\* = 700 N

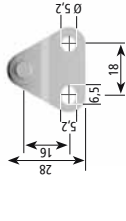

Part No. / Bestell-Nr. 8264WV  
F<sub>max</sub>\* = 1000 N

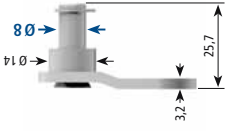
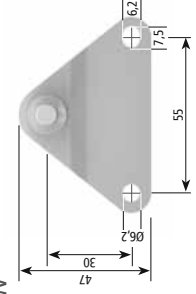
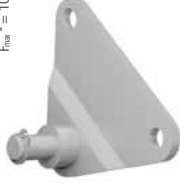

Part No. / Bestell-Nr. 8265WQ  
F<sub>max</sub>\* = 1000 N

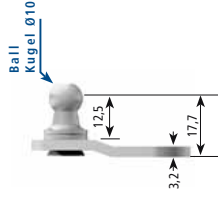
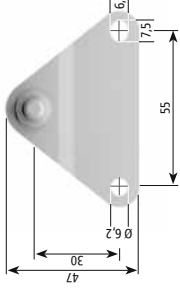

Part No. / Bestell-Nr. 023189  
F<sub>max</sub>\* = 700 N

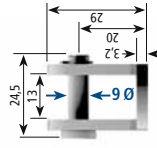
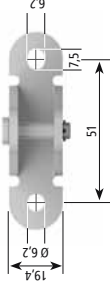

Part No. / Bestell-Nr. 023083  
F<sub>max</sub>\* = 1000 N

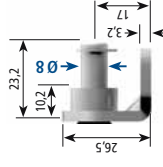
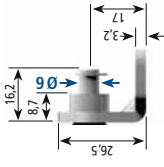
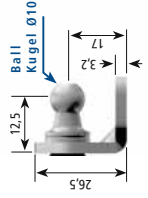
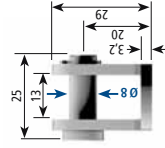
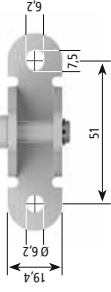

F<sub>max</sub>\* = Maximum allowable force at 20°C in compressed position. Material: steel, zinc-plated.  
F<sub>max</sub>\* = Maximale zulässige Belastung bei 20°C in eingeschobener Position. Material: Stahl, verzinkt.

Brackets for gas springs and dampers  
Winkelbleche für Gasfedern und Dämpfer

Part No. / Bestell-Nr. 92225J  
F<sub>max</sub>\* = 500 N



Part No. / Bestell-Nr. 7592TM  
F<sub>max</sub>\* = 350 N



Part No. / Bestell-Nr. 6284UG  
F<sub>max</sub>\* = 500 N



Ball stud / Kugelzapfen

45658D  
Clear passivated / Klar passiviert

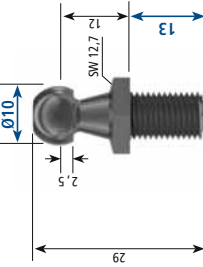

4486MD  
Black passivated / Schwarz passiviert

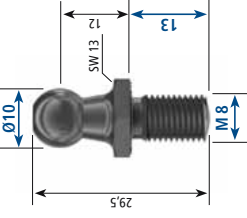

8442LT  
Black passivated / Schwarz passiviert

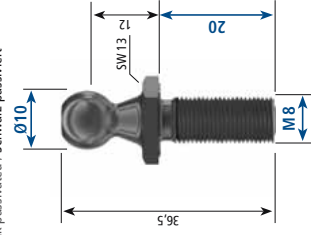

072796  
Black passivated / Schwarz passiviert

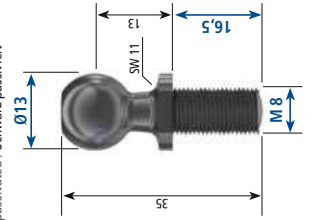

2054QF  
Clear passivated / Klar passiviert

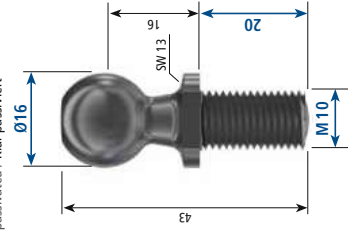

177583  
Black passivated / Schwarz passiviert

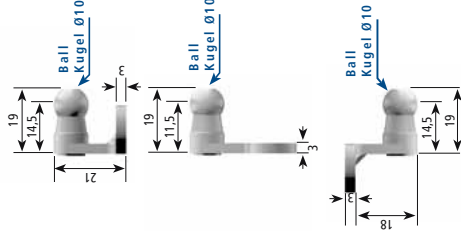
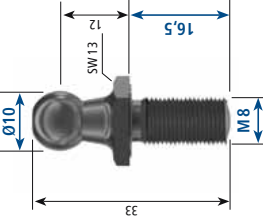

Stainless steel gas springs for  
the most demanding applications

The LIFT-O-MAT INOXLINE is a gas spring that is particularly corrosion resistant due to the use of AISI 316L steel (see DIN EN 100 88-1). It is used in critical environments, such as corrosive sea water, sea air or industrial exhaust gases. Its corrosion resistance will ensure a high level of protection even during acid or lye exposure. Carefully chosen materials for the LIFT-O-MAT INOXLINE components yield a virtually iron-free, non-magnetic product. This is especially attractive in medical and military technology as the stainless steel gas springs will barely interfere with the magnetic fields used in these indus-

Advantages

- High corrosion protection
- Non-magnetic
- Environmentally friendly fluids
- Compact design
- Maintenance-free

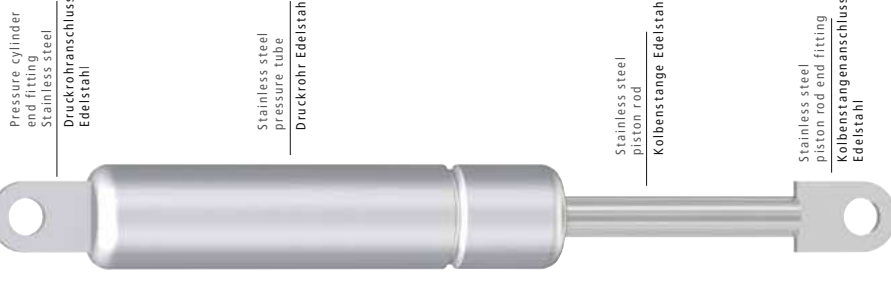

Edelstahl-Gasfedern für besonders  
anspruchsvolle Anwendungen

Der LIFT-O-MAT INOXLINE ist eine Gasfeder, die durch Verwendung von AISI 316L-Stahl besonders korrosionsbeständig ist (s. DIN EN 100 88-1). Er wird bei aggressiven Umweltebedingungen eingesetzt, z.B. bei korrosivem Seewasser, Seeluft oder Industrieabgasen. Wegen seines hohen Korrosionsschutzes gewährleistet er auch bei Säure- und Laugenbelastung einen hohen Schutz. Durch die besondere Materialauswahl der verwendeten Bestandteile der LIFT-O-MAT INOXLINE resultiert ein weitestgehend eisenfreies und somit nicht magnetisches Produkt. Dies kommt vor allem der Medizin- und Militärtechnik zu Gute, da die dort verwendeten Magnetfelder kaum von den Edelstahl-Gasfedern beeinflusst werden.

Vorteile

- Hoher Korrosionsschutz
- Nicht magnetisch
- Umweltfreundliche Füllungen
- Kompakte Bauweise
- Wartungsfrei

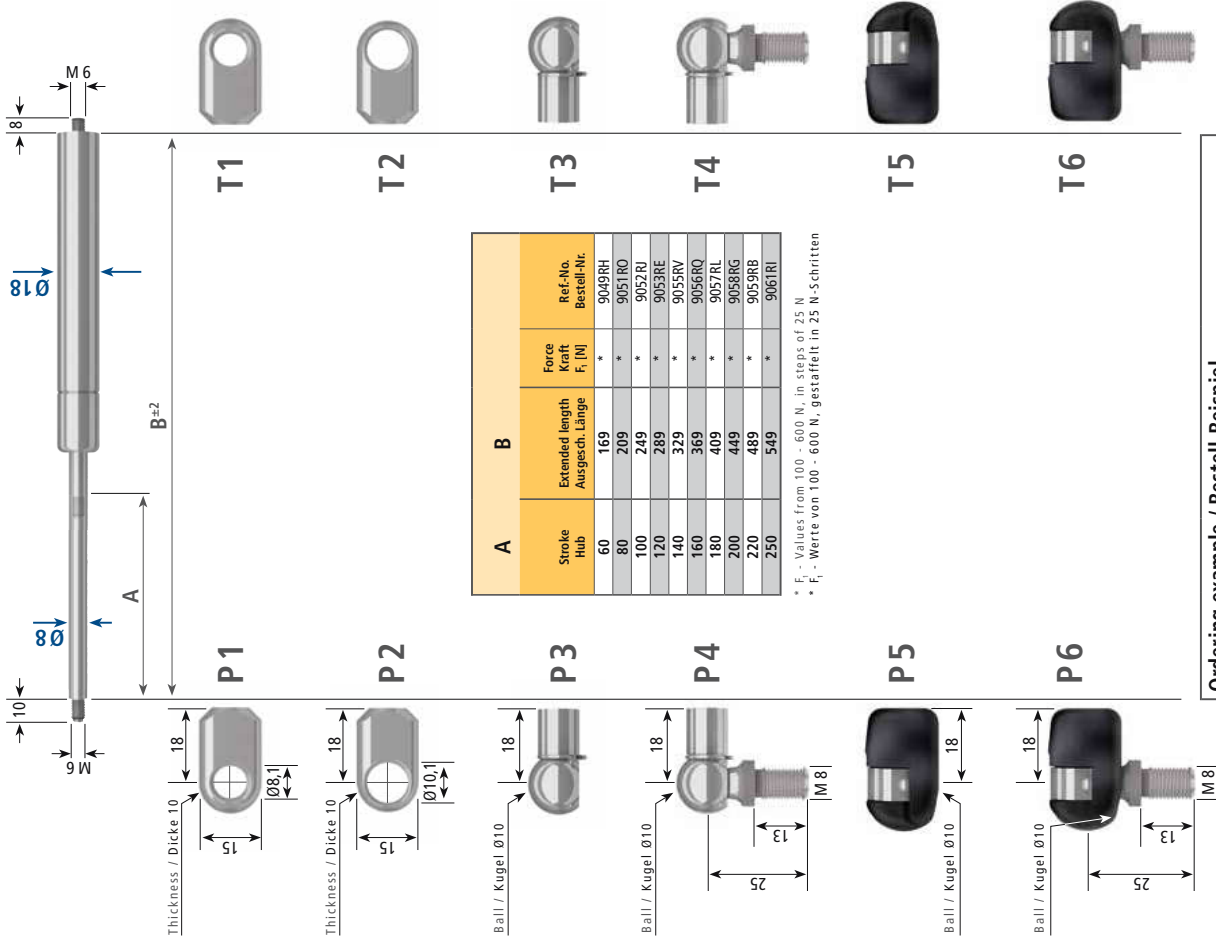

| A             |                                    | B      |   | Force<br>Kraft<br>F <sub>1</sub> [N] | Ref.-No.<br>Bestell-Nr. |
|---------------|------------------------------------|--------|---|--------------------------------------|-------------------------|
| Stroke<br>Hub | Extended length<br>Ausgesch. Länge | A      | B |                                      |                         |
| 60            | 169                                | 9049RH | * | 9049RH                               |                         |
| 80            | 209                                | 9051RO | * | 9051RO                               |                         |
| 100           | 249                                | 9052RI | * | 9052RI                               |                         |
| 120           | 288                                | 9053RE | * | 9053RE                               |                         |
| 140           | 329                                | 9055RV | * | 9055RV                               |                         |
| 160           | 369                                | 9056RQ | * | 9056RQ                               |                         |
| 180           | 409                                | 9057RL | * | 9057RL                               |                         |
| 200           | 449                                | 9058RG | * | 9058RG                               |                         |
| 220           | 489                                | 9059RB | * | 9059RB                               |                         |
| 250           | 549                                | 9061RI | * | 9061RI                               |                         |

\* F<sub>1</sub> - Values from 100 - 600 N, in steps of 25 N  
 \* F<sub>1</sub> - Werte von 100 - 600 N, gestaffelt in 25 N-Schritten

| Ordering example / Bestell-Beispiel |                |   |   |    |   |    |
|-------------------------------------|----------------|---|---|----|---|----|
| 123456                              | /              | 0350N   | / | P2 | / | T1 |
| Ref.-No.<br>Bestell-Nr.             | F <sub>1</sub> | Piston rod end fitting<br>Kolbenstangen-Anschluss |   | P2 | / | T1 |
|                                     |                | Pressure tube end fitting<br>Druckrohr-Anschluss  |   |    |   |    |

Installation according to STAB-Spec. 10022248  
 Montage nach STAB-Spec. 10022248

We reserve the right to make modifications. Dimensions in mm.  
 Änderungen vorbehalten. Maßangaben in mm.

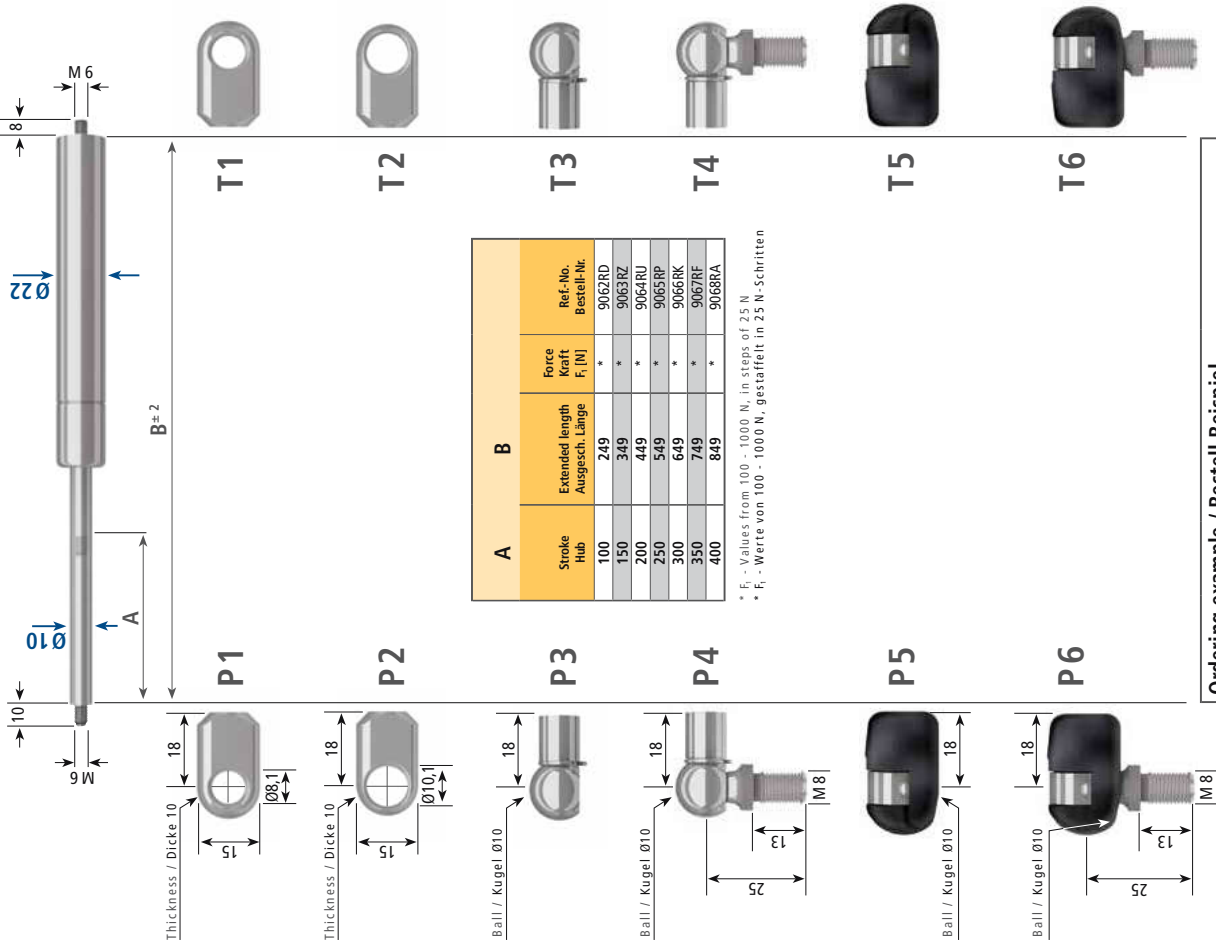

| A             |                                    | B      |   | Force<br>Kraft<br>F <sub>1</sub> [N] | Ref.-No.<br>Bestell-Nr. |
|---------------|------------------------------------|--------|---|--------------------------------------|-------------------------|
| Stroke<br>Hub | Extended length<br>Ausgesch. Länge | A      | B |                                      |                         |
| 100           | 249                                | 9062RD | * | 9062RD                               |                         |
| 150           | 349                                | 9063RZ | * | 9063RZ                               |                         |
| 200           | 449                                | 9064RU | * | 9064RU                               |                         |
| 250           | 549                                | 9065RP | * | 9065RP                               |                         |
| 300           | 649                                | 9066RK | * | 9066RK                               |                         |
| 350           | 749                                | 9067RF | * | 9067RF                               |                         |
| 400           | 849                                | 9068RA | * | 9068RA                               |                         |

\* F<sub>1</sub> - Values from 100 - 1000 N, in steps of 25 N  
 \* F<sub>1</sub> - Werte von 100 - 1000 N, gestaffelt in 25 N-Schritten

| Ordering example / Bestell-Beispiel |                |   |   |    |   |    |
|-------------------------------------|----------------|---|---|----|---|----|
| 123456                              | /              | 0350N   | / | P2 | / | T1 |
| Ref.-No.<br>Bestell-Nr.             | F <sub>1</sub> | Piston rod end fitting<br>Kolbenstangen-Anschluss |   | P2 | / | T1 |
|                                     |                | Pressure tube end fitting<br>Druckrohr-Anschluss  |   |    |   |    |

Installation according to STAB-Spec. 10022260  
 Montage nach STAB-Spec. 10022260

We reserve the right to make modifications. Dimensions in mm.  
 Änderungen vorbehalten. Maßangaben in mm.