

Gabeln und Gabelgelenke

Material Stahl blau verzinkt

Optional Edelstahl W.1.4305/AISI 303 (V2) und W.1.4404/AISI 316 (V4)

M 3,5

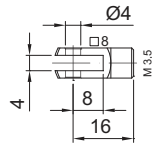

GA 16

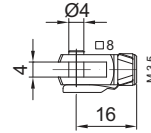

GG 16

M 5

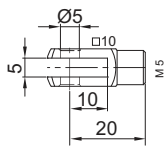

GA 20
V2*

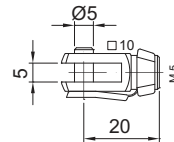

GG 20
V2*/V4*

M 8

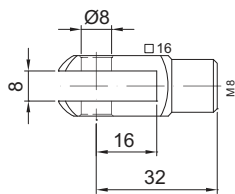

GA 32
V2*

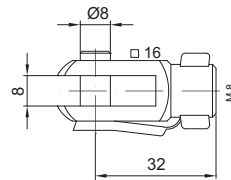

GG 32
V2*/V4*

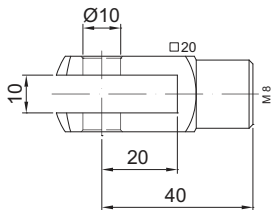

GS 40

M 10

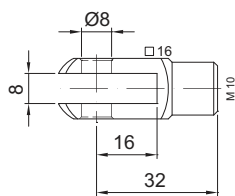

GS 32

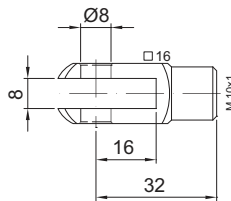

GX 32

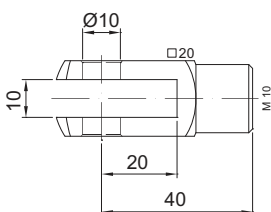

GA 40
V2*

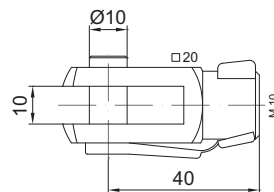

GG 40
V2*/V4*

* Gabelgelenke V2 mit BEN-Bolzen, Gabelgelenke V4 mit Splint-Bolzen

Gabeln und Gabelgelenke

Material Stahl blau verzinkt

Optional Edelstahl W.1.4305/AISI 303 (V2) und W.1.4404/AISI 316 (V4)

M 14

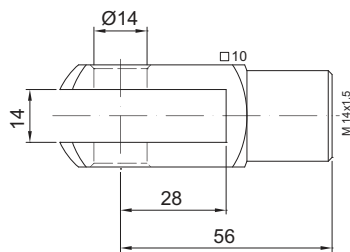

GA 56
V2*

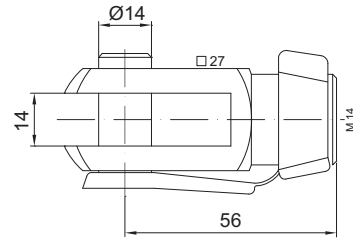

GG 56
V2*/V4*

M 20

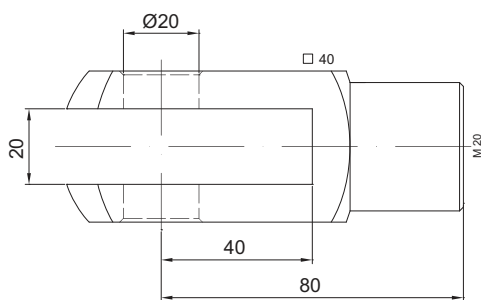

GA 80

M 24

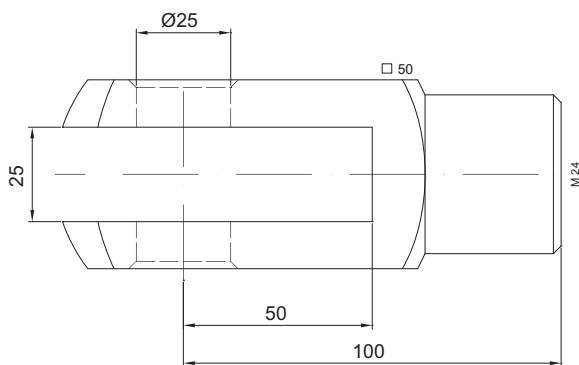

GA 99

* Gabelgelenke V2 mit BEN-Bolzen, Gabelgelenke V4 mit Splint-Bolzen